

Product description **M12 Twin distributor, T-distributor, male connector M12x1 - 2 female connector M12x1, Contacts: 5, unshielded, pluggable, IP68, UL**

Area **series 765**
Part no. **79 5255 190 05**

Illustration



Pin assignment plans

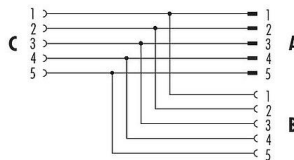

Scale drawing

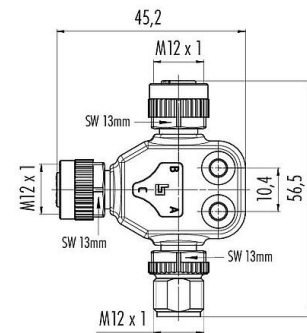

Contact arrangement (Plug-in side)

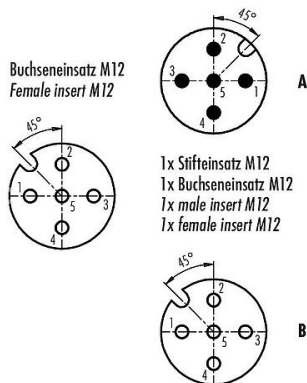

Technical data

General features

Part no.

79 5255 190 05

Connector design

Twin distributor, T-distributor, male connector M12x1 - 2 female connector M12x1

Product description	M12 Twin distributor, T-distributor, male connector M12x1 - 2 female connector M12x1, Contacts: 5, unshielded, pluggable, IP68, UL
Area	series 765
Part no.	79 5255 190 05

Type standard	DIN EN 61076-2-101
Version	Twin distributors
Connector locking system	screw
Termination	pluggable
Degree of protection	IP68
Temperature range from/to	-25 °C / 85 °C
Mechanical operation	> 100 Mating cycles
Weight (g)	28.00
Customs tariff number	85444290
Country of Origin	DE

Electrical parameters

Rated voltage	60 V
Rated impulse voltage	1500 V
Rated current	4.0 A
Pollution degree	3
Overvoltage category	II
Insulating material group	II
EMC compliance	unshielded

Material

Housing material	PUR
Contact body material	PUR
Contact material	CuZn (brass) / CuSn (bronze)
Contact plating	Au (gold)
Locking material	Zinc die-cast nickel-plated
REACH SVHC	None (No pollutants)
SCIP number	SCIP-number not available

Authorization/approvals

Approvals	UL
-----------	----

Classifications

eCl@ss 11.1	27-06-03-11
ETIM 9.0	EC002638

Declarations of conformity

Low Voltage Directive	2014/35/EU (EN 60204-1:2018;EN 60529:1991)
RoHS Directive	2011/65/EU (EN 50581:2012)

Product description	M12 Twin distributor, T-distributor, male connector M12x1 - 2 female connector M12x1, Contacts: 5, unshielded, pluggable, IP68, UL
Area	series 765
Part no.	79 5255 190 05

Security notices

The connector must not be plugged or unplugged under load. Non-observance and improper use can result in personal injury.

The connectors have been developed for applications in plant engineering, control and electrical equipment construction. The user is responsible for checking whether the connectors can also be used in other areas of application.

Connectors which are used in circuits with voltages dangerous to the touch may only be installed and used by, or under the supervision of, persons with electrical engineering training, taking into account the applicable regulations and standards.

The user must take suitable safety precautions to ensure that the connector cannot be accidentally disconnected.

Plug connectors with enclosure protection IP67 and IP68 are not suitable for use under water. When used outdoors, the plug connectors must be protected separately against corrosion. For further information on the IP protection classes, please refer to the "Technical Information" download centre.

The plug connector is not suitable for mains voltages. Please observe the pollution degree and the overvoltage category. For further information, please refer to the download center "Technical Information".

To lock the cable connector with the device connector, the threaded ring is tightened "hand-tight" (approx. 60 cNm).